

TECHNICAL DOCUMENTATION INSTALLATION INSTRUCTIONS



AQA 300/AQA 500



812520_Rev.6 - Translation of original instruction

Hot water tank for drink water preparation

www.idm-energie.at

1. GENERAL INFORMATION	3
1.1. General information	3
1.2. Safety Instructions	3
1.3. Transport	3
1.4. Servicing and maintenance	3
1.5. Cleaning	3
1.6. Installing additional components	3
1.7. Installation Room	3
1.8. Protection of the environment	4
1.9. Standards and directives	4
2. DESCRIPTION	5
2.1. Description	5
2.2. Scope of delivery	5
2.3. Design information	5
3. TECHNICAL SPECIFICATIONS	6
3.1. Technical data AQA 300, AQA 500	6
3.2. Dimensional drawings AQA 300, AQA 500	7
4. INSTALLATION	8
4.1. Setup conditions AQA 300/AQA 500	8
4.2. Setup location AQA 300/AQA 500	8
4.3. Connecting sleeves Hygienik	8
4.4. Drink water-side connection	8
4.5. Hot water circulation	8
4.6. Filling, Emptying	9
4.7. Water preparation	9
4.8. Magnesium-anode	9
5. APPLICATIONS OVERVIEW	10
5.1. Drawing explanation and notes on the overview of the applications	10
5.2. Overview of applications	11
6. MAGNESIUM PROTECTION ANODE	14
6.1. General	14
6.2. Inspection of the magnesium protection anode	14
6.3. Replace of the magnesium protection anode	15

1.1. General information

Please read this documentation carefully. It contains important information for correct installation and safe and economical operation of the system.

1.2. Safety Instructions

Installation and maintenance work can be hazardous due to high system pressure, high temperatures and live parts and may only be operated by specialist staff.

Hot water tanks may only be installed by competent specialist staff and commissioned by a customer service company trained to do so by IDM-Energie-systeme GmbH.

When working on the hot water tank, the system must be deactivated and secured against reactivation.

In addition, all safety instructions in the relevant documentation, stickers on the hot water tank itself and all other applicable safety regulations must be observed.

1.3. Transport

For transport, deployment and installation use lifting tools, which conforms to the weight and dimension of the hot water tank. Due to the high deadweight of the tank there is a high risk of accidents.



General instructions on operating the hot water tank.



Important instructions on assembling and operating the hot water tank. It is imperative that these are observed!

1.4. Servicing and maintenance

Regular maintenance as well as checking and servicing of all system components guarantee its safe and economical operation in the long term. To achieve this, we recommend a maintenance contract with the relevant customer service company.

Only original IDM spare parts or spare parts which correspond to IDM-specifications are allowed!

1.5. Cleaning

If necessary, the hot water tank can be cleaned with a damp cloth. The use of aggressive cleaning agents is not recommended.

1.6. Installing additional components

The installation of additional components which have not been tested with the equipment may impair function. No liability is accepted and the guarantee becomes void in the event of damage caused for this reason.

1.7. Installation Room

- No heavy dust formation
- No persistent air humidity
- Frost-proof
- Ensure, that the statics of the relevant installation area and breakthroughs in ceilings and walls for installation will not be endangered and therefore suitable is.



General instructions on assembling the hot water tank.



Space for customer service telephone number

1.8. Protection of the environment



The hot water tank is made from high valuable materials, which are not allowed to be disposed like normal household garbage, but have to be disposed professional and proper according the regulations of the local authorities.

A non-proper disposal can cause, apart from sanctions for the violator, environmental damages and harm for your health.

1.9. Standards and directives



Note for the installation follow all effective national and international piping- and installation rules same as rules for accident prevention and safety regulations when installing pipeline systems and electrical components and equipment as well as the instructions of this installation instruction.

There to belongs among other things:

- the general effective rules for accident prevention and safety regulations
- the regulations for environmental protection
- the provisions/regulations of the professional associations.
- the effective laws, standards, guidelines and regulations
- e.g. DIN, EN, DVGW, VDI and VDE
- regulations of the local suppliers/supply companies.

2.1. Description

The hot water tank AQA 300 and AQA 500 consists of high quality steel with a special enameling of the inner surface.

An additional magnesium-anode prevents corrosion. The boilers are equipped with a thermometer, anode and a 50mm PU-rigid foam insulation.

The insulation ensures that the boiler emits very little heat.

The AQA 300 can be operated with a heatpump up to 15 kW, the AQA 500 with a heatpump up to 20 kW heat output.



In case an electrical heating element will be installed in the thermal storage tank, an additional safety device must be installed at the thermal storage tank!



2.2. Scope of delivery

AQA 300, AQA 500:

- Boiler chassis with internal baretube, enameled
- Magnesium-anode
- PU-rigid foam insulation
- PS-lamination jacket
- Plastic cover
- Thermometer
- Leveling feet to adjust the boiler

2.3. Design information

The hot water tank is available in two different sizes.

„Boiler capacity AQA 300, AQA 500“

Capacity	Intended purpose
270 litres	for a single family home, eventually with an solar system
425 litres	

„One-off tap capacity“

This is the total quantity of hot water with 45 °C which can be tapped from the hot water tank, if the storage vessel is heated to 55 °C below and is not reheated from the heater.

„Hot water requirements“

The hot water requirements for a building must be ascertained in accordance with DIN 4708, Part 2 or in accordance with the “Sander Procedure”.

3. Technical Specifications

3.1. Technical data AQA 300, AQA 500

Tech Data \ Type		AQA 300	AQA 500
Storage capacity	l	295	467
Usable storage capacity	l	270	425
Register heating surface	m ²	3,5	5,9
Capacity tube register	l	25	42
Max hot water temperature	°C	55	55
One-time tap volume at 45°C tap temperature and 55°C boiler temperature	°C	348	566
Max. operating pressure drink water side	bar	10	10
Max. operating pressure heating side	bar	10	10
Max. operating temperature drink water side	°C	90	90
Max. operating temperature heating side	°C	95	95
Height	mm	1835	1970
Diameter	mm	650	750
Topple measure	mm	1883	2044
Weight	kg	90	160
Energy efficiency class		B	B
Average thermal dissipation loss		58 W	76 W

EC-Declaration of Conformity

IDM-Energiesysteme herewith declares, that the hot water storage tanks, described overleaf, fulfill the provisions of the following relevant Community harmonization legislation:

- Directive 2009/125/EC of the European Parliament and of the Council of October 21st, 2009 on the establishment of a framework for the setting of eco-design requirements for energy-related products.
- Directive 2010/30/EU of the European Parliament and of the Council of May 19th, 2010 on the indication of the consumption of energy and other resources by energy-related products, by labelling and standard product information.

The delegated regulation (EU) No 814/2013 of the commission of August 2nd, 2013, as well as the delegated regulation (EU) No 812/2013 of the commission of February 18th, 2013, have also been fulfilled.

The following standards and technical specifications of hot water storage tanks have been applied:
 DIN EN 12897 Water supply – Specification for indirectly heated unvented (closed) storage water heaters; German version EN 12897:2006

3.2. Dimensional drawings AQA 300, AQA 500

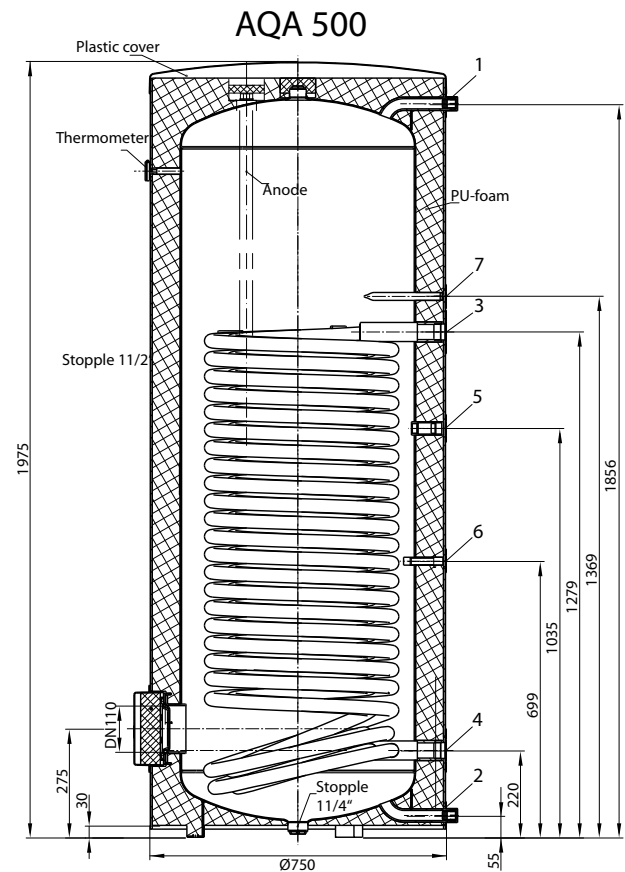
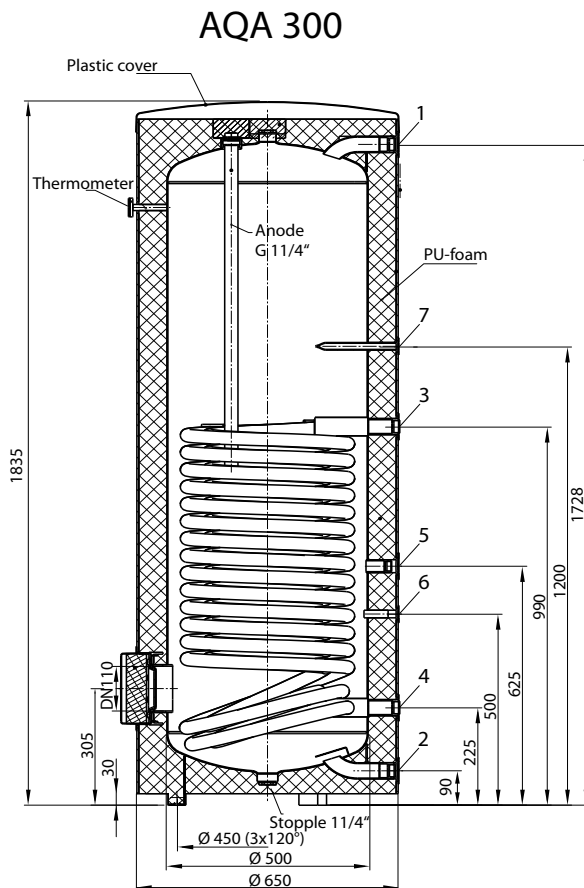

Pos.	Connection	Dimension
1	Hot water forward flow	R 1" IG
2	Cold water return flow	R 1" IG
3	Forward flow heat pump	R 1" IG
4	Return flow heat pump	R 1" IG
5	Connection circulation	R 3/4" IG
6	Sleeve for temperature sensor	di=20mm
7	Sleeve for temperature sensor	di=20mm

Pos.	Connection	Dimension
1	Hot water forward flow	R 1" IG
2	Cold water return flow	R 1" IG
3	Forward flow heat pump	R 1 1/4" IG
4	Return flow heat pump	R 1 1/4" IG
5	Connection circulation	R 3/4" IG
6	Sleeve for temperature sensor	di=20mm
7	Sleeve for temperature sensor	di=20mm

4. Installation

4.1. Setup conditions AQA 300/AQA 500

Set up the boilers as close as possible to the drinking water tap point, in order to keep the water routes as short as possible and prevent a circulation line.

When storing, transporting and assembling the components, it must be ensured that no mechanical effects such as deformations, scratches and tensions occur.

4.2. Setup location AQA 300/AQA 500

The boilers must be set up in a frost-free room by an approved specialist company.

The relevant laws, regulations and standards both for heating house piping and for sanitation installations must be observed.

A free space should be adhered around the IDM-Hygienik 300I for easy access to the connections.

4.3. Connecting sleeves Hygienik

Dimensions for the connecting sleeves are mentioned on page 9.

4.4. Drink water-side connection

The hydraulic integration is realized according to the indicated schemes (for this see chapter „Applications overview“).

The connection dimensions are listed in chapter “Dimensional drawings” on page 9.

The hot water tank is convenient for drink water (pH-value > 7,3) according to DIN 50930-6. The connection pipe work can be made with galvanised pipes, stainless steel pipes, copper pipes or plastic pipes.

The connections must be realised pressure-tight.

The component-tested safety devices as per DIN 1988 and DIN 4753 must be installed in the cold water line (see figures below).

The operating pressure of 10 bar indicated on the type plate must not be exceeded. If necessary a pressure reducer must be installed.

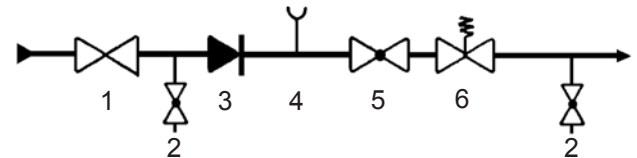

- 1...Pressure reducer (only at more than 6 bar)
- 2...Emptying valve
- 3...Backflow preventer
- 4...Pressure gauge connecting piece 1/2"
- 5...Shut-off valve
- 6...Diaphragm safety valve

A dirt collector is installed in the cold water line. In the case of hard water a water softening device should be installed.

4.5. Hot water circulation

If longer pipe is required for hot water, a circulation pump is necessary to keep up the water temperature so that hot water is instantly available. According to DVGW sheet, no. 551, a hot water circulation pipe to protect against legionella is prescribed if the pipe's capacity is larger than 3 litres.

According to DVGW sheet no. 551, the temperatures of the hot water in the circulation pipe should be periodically increased up to 60°C.

The IDM Navigator controller is equipped with a special circulation pump control.

The Navigator controller, the control of a circulation pump is possible, when the digital output on the Navigator main board is not used for common fault signal.

4.6. Filling, Emptying

Corresponding filling- and emptying valves should be provide for easy filling and emptying.

For frost-proof emptying the hot water tank must be emptied at the points provided for this. All non-return valves must be opened for this.

4.7. Water preparation

In order to prevent damage through calcification on heat exchange surfaces, the water must be treated in accordance with VDI Directive 2035, EN 12828 or ÖNORM H5195.

4.8. Magnesium-anode

The Magnesium-anode should be checked every two years. In case of changing the anode, the electrical connections to the tank must be observed!



If no drinking water can be tapped, even although the temperature in the Hygienik is sufficient, the following points must be checked:

- **Pressure of the system (should be approx. 2 bar)**
- **Open upper ventilation valve and check whether air is in the storage vessel**

5. Applications Overview

5.1. Drawing explanation and notes on the overview of the applications

Legend and reference to the schemes

IDM apply many and wide-ranging innovative technical solutions to both new and existing systems. Innovation through diversity is accounted in the same extent as using already present heat supplying systems.



























The following design variations are proposals. The sketches do not reflect complete equipments with all necessary components.

For installation and operation purposes, all guidelines and instructions in the relevant assembly manual should be followed.



The following pages contain a range of heat system variations. For tailor-designed systems to suit individual requirements, you should always work closely with an IDM-trained designer!!

Shortcut	
HC	Heating circuit
CW	Cold water
WW	Warm water

Symbol	Meaning
	Heat emitting system (Low-temperature heating)
	Circulation pump
	Three-way mixer (without bypass) motor drive
	Three-way mixer Thermal actuation
	Check valve
	Ball valve
	Flow control valve
	Flow switch
	Safety valve
	Heating manometer
	Expansion tank
	Temperature sensor
	Flow control sensor
	Buffer tank sensor
	Outdoor sensor
	Room control with offset for heating circuit A
	Room control with offset for heating circuit C
	Room thermostat
	Control thermostat
	Air separator
	Dirt separator
	Flow meter
	Restriction valve
	Filter
	Flow meter
	Electrical heater

5.2. Overview of applications

Design variations	Variation Code	Chapter
TERRA IL Complete + AQA + direct heating circuit	N_2.10-7-10-0-1-0	5.2.1
TERRA ML 8-18 + AQA + direct heating circuit	N_2.17-7-10-0-1-2	5.2.2
TERRA SW Complete HGL + AQA + TERMO + 1 HC	N_1.3-0-10-11-1-0	5.2.3
TERRA SW + AQA + TERMO + 1 HC	N_2.19-0-10-11-1-0	5.2.4

Note:

This schemes are only a tentative suggestion for installing an IDM heat pump in the heating system. This suggestion replaces no professional planning of an executing company! On part of IDM-Energiesysteme can no warrenty be taken concerning the function of the whole system!



Install a 18l expansion vessel in the buffer when a TERRA IL Complete or TERRA ML 8-18 with direct heating circuit is used in combination with the AQA 300/AQA 500.

The heat emission system must be a floor heating.

With optional boards for heating circuits, it is possible to control up to six circuits.

The HGL system allows higher storage temperatures to be attained.

TERRA IL Complete + AQA + direct heating circuit N_2.10-7-10-0-3-0

When using direct heating circles and zone-valves, at least 25 % of the zones have to be opened all the time.
Exception: At systems with Navigator Pro 2.0 not any zones should not be open!

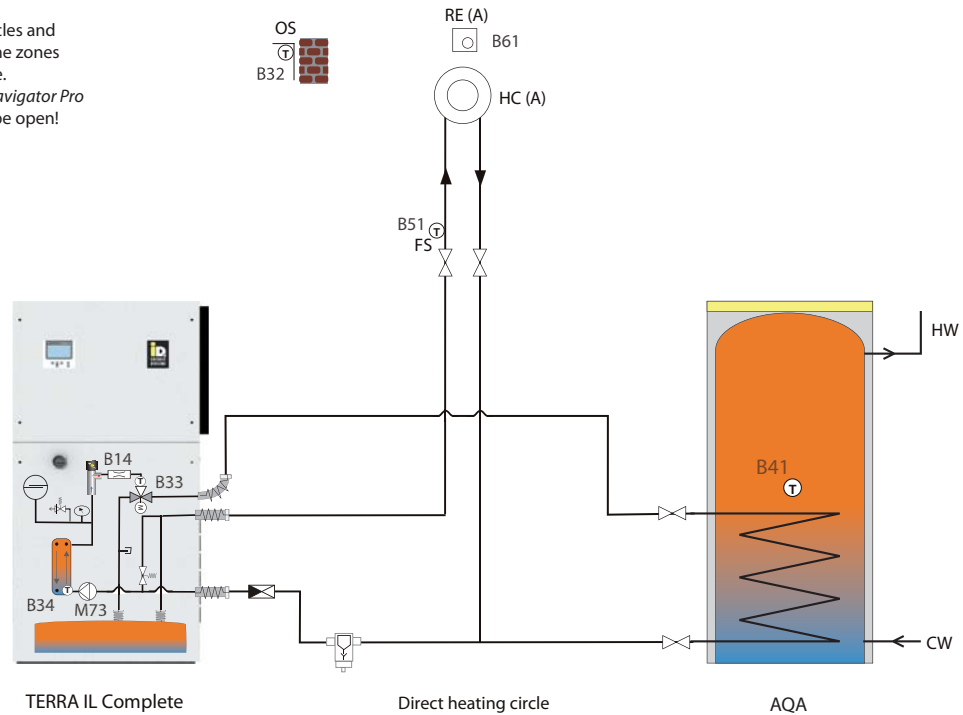

TERRA ML 8-18 no HGL + AQA + direct heating circuit N_2.17-7-10-0-3-0

When using direct heating circles and zone-valves, at least 25 % of the zones have to be opened all the time.
 Exception: At systems with Navigator Pro not any zones should not be open!

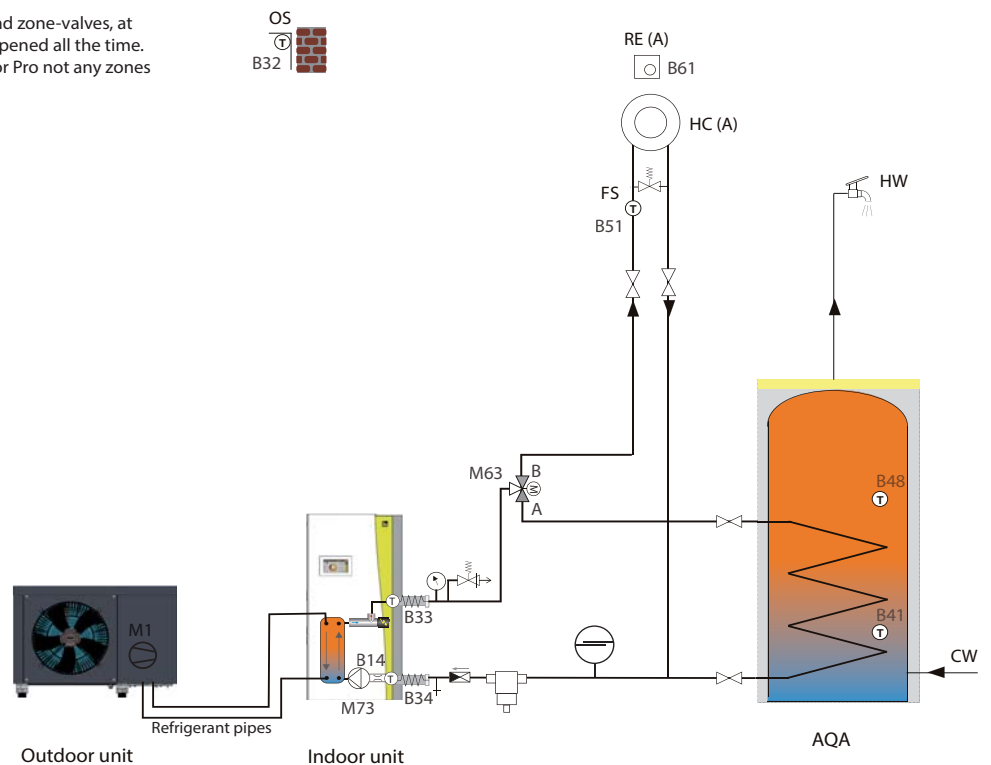

TERRA SW Complete HGL + AQA + TERMO + 1 HC N_1.3-0-10-11-1-0

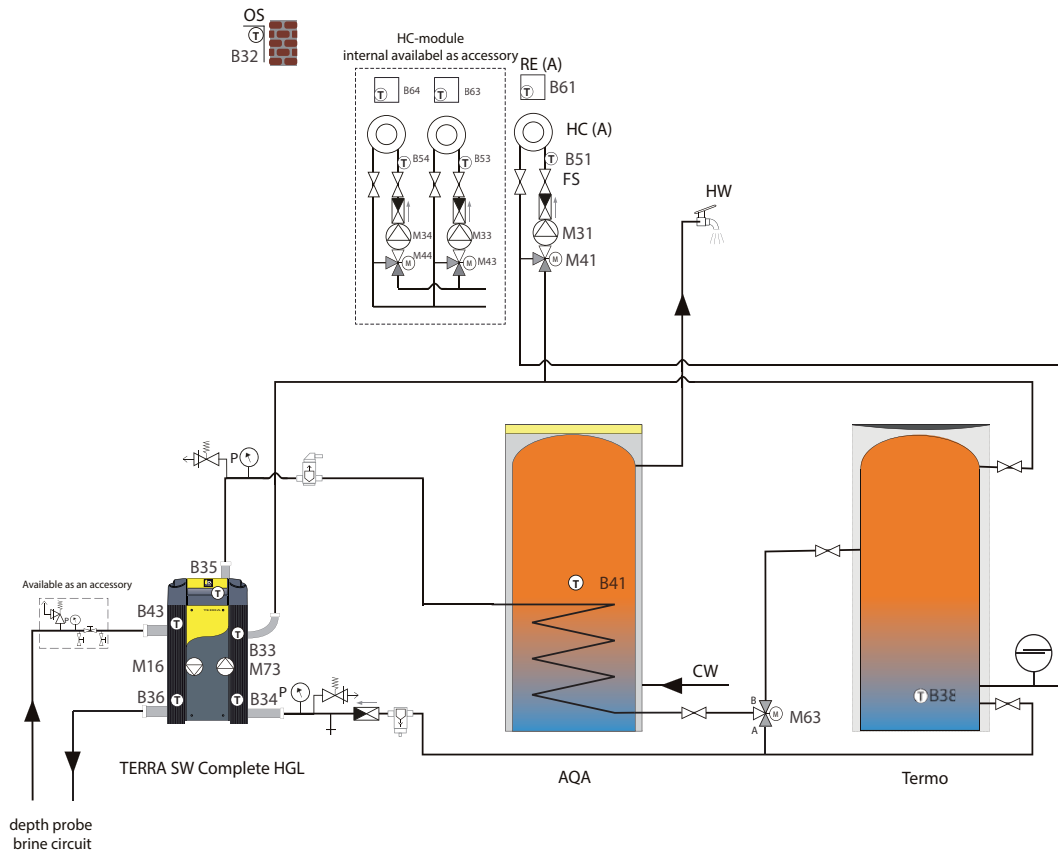

TERRA SW Complete + AQA + TERMO + 1 HC N_2.19-0-10-11-1-0

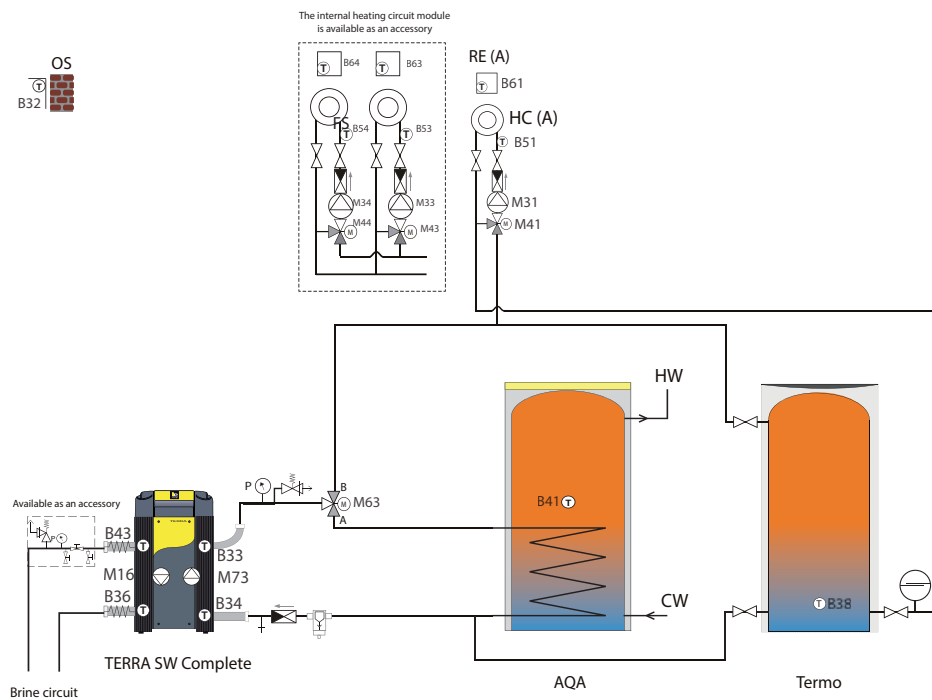

6. Magnesium protection anode

6.1. General

The anode, which is in the AQA 300I and AQA 500I must be subjected to a functional test in accordance to DIN 4753-3 for the first time after 2 years and subsequently annually. The replacement of the anode is described on the next page.

Anode test

A guidance how to test the anode can be viewed under the following link:

<https://www.youtube.com/watch?v=ZwuTNWZ8e6o>

Type of the anode in AQA 300I and AQA 500I

Sacrificial anode_ Mg_5/4“_Ø33xL558/528 insulated

MAGONTEC.0126033004000500

Item.nr. 540577

6.2. Inspection of the magnesium protection anode

The integrated magnesium protection anode in the AQA 300I and AQA 500I is insulated. , The protection current (mA DC) of the anode can be checked in installed condition with the help of an anode tester or multimeter. For this the buffer must be filled with water. The connection line (black) between the anode and the buffer must be disconnected and the measuring instrument must be connected in series between the anode and the buffer (contact closed). After 30 sec. the measurement adjusts.

Interpretation of the measurement results

The measured values are depending on the quality of the enamel, buffer size, water conductivity, water temperature, installation of brass immersion sleeves or non-enamelled components. For AQA 300I and AQA 500I, the measured protective currents are in a range of >1 mA. As a critical minimum level, a protection current of <0.3 mA can be considered. Since no corrosion protection is given, the anode must be replaced.

Typical measurements AQA 300I and AQA 500I

Resistance $R = 500 \text{ k}\Omega$, protection current $I = 0.55 \text{ mA DC}$

Note from the buffer manufacturer

Please note that the measured protective current indicates the function or non-functioning of the magnesium protective anode, but there is no guarantee for sufficient protection conditions in the buffer!

6.3. Replace of the magnesium protection anode

Before the magnesium protection anode can be replaced, the system must be depressurized by emptying of a small portion of water. The anode is placed under the black cover on the top of the buffer.



The foam, which serves as insulation in the area of the protective anode, must be removed.



After this the connection line between the anode and the buffer must be disconnected.



The used anode is removed by a suitable pipe wrench.



The new anode will be installed and bolted tightly. The black connection cable between the anode and the buffer must be connected again.



After the installation of the chain anode the drained water must be refilled. Before restarting the system, the storage tank must be checked for leaks in the area of the protection anode.

Always there for you:

© IDM ENERGIESYSTEME GMBH
Seblas 16-18 | A-9971 Mauterhorn in Osttirol
www.idm-energie.com | team@idm-energie.at

iDM service technology:

COMMISSIONING – SERVICING – ON-SITE SERVICE

Our service technicians are happy to help on-site. Contact details for your regional customer service centre can be found on our website **www.idm-energie.com**.

iDM Academy:

PRACTICAL KNOWLEDGE FOR SALES AND TECHNOLOGY

The comprehensive range of seminars for specialists at the iDM POWER FAMILY is available to you and any time on our website **www.idm-energie.com**. We look forward to receiving your registration.

Your iDM partner:

